

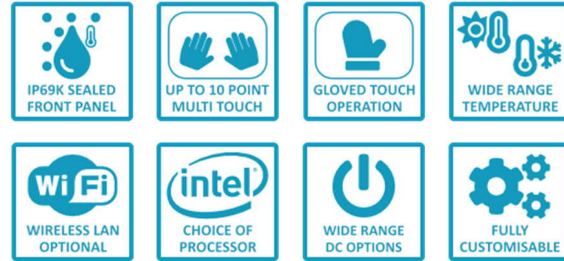

Fully customisable 21.5" Industrial Panel PC / Thin Client / Monitor



Overview

Our W21 Product Range offers high-performance, low-power industrial computing in an 21.5" form factor, with flexible configurations as a Panel PC, Thin Client, or Industrial Monitor. Its IP69K front seal ensures protection against dust ingress and high temperature, high-pressure water, making it an ideal choice for sanitary environments such as in the Food Industry. For specifications and custom requirements, reach out to us. We're here to provide tailored solutions.

General Specifications

DISPLAY	
LCD Size	21.5" (16:9)
Max Resolution	1920 x 1080
Brightness (cd/m ²)	300
Contrast Ratio	1000 : 1
Viewing Angle (H/V)	178 / 178
Colour Depth	16.7M
TOUCHSCREEN	
Technology	PCAP
Cover Lens	4mm flush Polycarbonate filter UV stabilised
Surface Hardness	5H
Connectivity	USB or RS232
Multi-Touch	Up to 10 points
POWER	
Supply Voltage	90-264VAC or 9-36VDC
Power Consumption	PC – See Appendix A Monitor – 20W typ.
MECHANICAL	
Material	Stainless Steel (304) front face / Anodised Aluminium rear face
Mounting	Cased or Bezel
Dimensions (mm)	548 (W) x 391.11 (H) x 75.5 (D) cased
Weight (g)	15Kg
ENVIRONMENTAL	
Operating Temperature	-5°C to +50°C *
	* Extendable to -25°C to +65°C.
Storage Temperature	-20°C to +70°C
Relative Humidity	90% non-condensing
IP Seal Level	IP66 / IP67 / IP69K
WARRANTY	
Warranty Period	3 Years standard return to base. Extendable to 5 Years if required



Main System Options

Panel PC	See Appendix A for specifications
Axel Thin Client	See Appendix B for specifications
Raspberry Pi Client	See Appendix C for specifications
Monitor Only	VGA, DVI and HDMI. (DP+ via an adapter cable)

APPENDIX A			
MOTHERBOARD	EL	N100	I5
Form Factor	Mini-ITX	Mini-ITX	Mini-ITX
CPU	Intel® Celeron® J6412 2.0Ghz	Intel® N100 up to 3.4Ghz	Intel® Core™ i5-1235U 2.40Ghz
Core Number	4	4	10
Chipset	-	-	-
BIOS	AMI UEFI	AMI UEFI	AMI UEFI
Graphics	Intel® UHD Graphics	Intel® UHD Graphics	Intel® Iris® Xe Graphics
HDMI	1 x Supports HDMI 1.4b, max resolution 4096 x 2160 @ 24Hz	1 x Supports HDMI 2.0, max resolution 4096 x 2160 @ 60Hz	4 x Supports HDMI 2.0, max resolution 4096 x 2160 @ 60Hz
DisplayPort	N/A	1 x DisplayPort++, max resolution 4096 x 2304 @ 60Hz	N/A
RAM	Up to 32GB (DDR4-2666)	Up to 32GB (DDR4-3200)	Up to 64GB (DDR4-3200)
SATA	1 x SATA3 (6.0Gb/s)	1 x SATA3 (6.0Gb/s)	1 x SATA3 (6.0Gb/s)
Mini-PCIe	1 x Full-Sized	N/A	N/A
M.2	1 x M.2 Key B 2242 (SATA3.0)	1 x M.2 Key M 2280 (SATA), 1 x M.2 Key E 2230 (PCIe x1 & USB2.0 & CNVi)	1 x M.2 Key M 2280 (NVMe), 1 x M.2 Key E 2230 (PCIe x1 & USB2.0 & CNVi)
Serial Ports	1 x RS232/RS422/485, 2 x RS232	1 x RS232/485, 2 x RS232	1 x RS232/485, 1 x RS232
USB Ports	4 x USB3	2 x USB3.2, 2 x USB2	4 x USB3.2
Ethernet	2 x 10/100/1000 Mbps	2 x 10/100/1000/2500 Mbps	1 x 10/100/1000 Mbps 1 x 10/100/1000/2500 Mbps
Audio	HD Audio (Realtek ALC897)	HD Audio (Realtek ALC897)	HD Audio (Realtek ALC897)
TPM	Infineon SLB9760 T2.0 TPM 2.0 compliant	Intel® PTT TPM 2.0 compliant	Intel® PTT TPM 2.0 compliant
Power	40W (Standard Op. Temp.) 160W (Extended Op. Temp.)	40W (Standard Op. Temp.) 40W (Extended Op. Temp.)	45W (Standard Op. Temp.) 45W (Extended Op. Temp.)
Storage Media	128GB – 512GB SSD	128GB – 512GB SSD	128GB – 512GB SSD
Operating System	Windows 10 IoT Enterprise LTSC 64-bit Windows 11 IoT Enterprise LTSC 64-bit	Windows 10 IoT Enterprise LTSC 64-bit Windows 11 IoT Enterprise LTSC 64-bit	Windows 10 IoT Enterprise LTSC 64-bit Windows 11 IoT Enterprise LTSC 64-bit

APPENDIX B	
AXEL THIN CLIENT	
Description	W21 monitor with Axel G15 built in
USB	4
Ethernet	1 x TCP/IP 10/100/1000BaseT LAN
Serial	2 x RS232
Parallel Port	By USB
Graphical Sessions	Microsoft TSE (from NT4 to 2008R2) / RemoteApp / Multipoint 2011, Citrix XenApp & Metaframe / XenDesktop / StoreFront & NetScaler, VMware View (RDP), Linux (VNC Client)
Text Sessions	AS/400 iSeries: 5250, S/390 zSeries: 3270, Unix/Linux: Telnet, SSH & TTY (ANSI, SCO OPENSERVICES, UNIX SCO 3.2.2, UNIX SCO 3.2.4, XENIX SCO, ANSI INTERACTIVE, UNIX SVR4, ANSI RS6000, ANSI DATA GENERAL, UNIXWARE 7, LINUX, VT100/VT220, VT52, WYSE 50/60/120, ADDS VP-A2, ADDS VP-60, IBM 3151, ATO300, PRISM, THEOS, OS2 POLYMOD2, SM9400, SM9412, TWINSERVER, PROLOGUE 3, TVI 950, QVT119+, C332)
Administration	Remote interactive set-up / Text sessions remote control / VNC remote control / Downloadable firmware / AXRM compliant

Appendix C

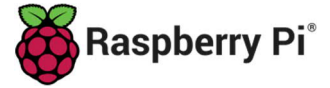

Raspberry Pi 4 B Features:

- Broadcom BCM2711, Quad core Cortex-A72 (ARM v8) 64-bit SoC @ 1.5GHz
- 4GB LPDDR4-2400 SDRAM
- 2.4GHz and 5GHz IEEE 802.11ac wireless LAN, Bluetooth 5.0, BLE
- Gigabit Ethernet
- 3 USB 3.0 ports, 2 USB 2.0 ports (1 x reserved to Touchscreen)

Various Operating Systems

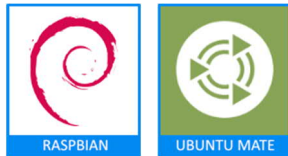

Remote Desktop Connection

A low-cost Thin Client for Remote Desktop Connections. Customers wanting to use a remote desktop connection to control an application installed on hardware elsewhere in the building, or anywhere in the world for that matter, can easily do so using the Raspberry Pi.

Web Browser Applications

If your business application is controlled via a web browser, then the Raspberry Pi is more than up to the task! Raspbian OS itself comes preinstalled with Chromium, an open-source browser project aimed at building a “safer, faster, and more stable way for all users to experience the web”.

Example Scenario:

In the following example, we have multiple Raspberry Pi Client PCs connected to the network via wired Ethernet, running a Web Browser to load an application hosted on a different site, across the internet. Connected to these Raspberry Pi Client PCs are wireless Bluetooth Handheld Scanners, used for scanning bar codes of items going through a line. The Raspberry Pi Client PCs can send and receive the required data to the Application Server via the Internet. A separate Raspberry Pi has been set up as a Remote Administration Client, connected to the network wirelessly. This Remote Administration Client can use a Remote Desktop Client to control and administer the Application and Database Servers over the Internet.

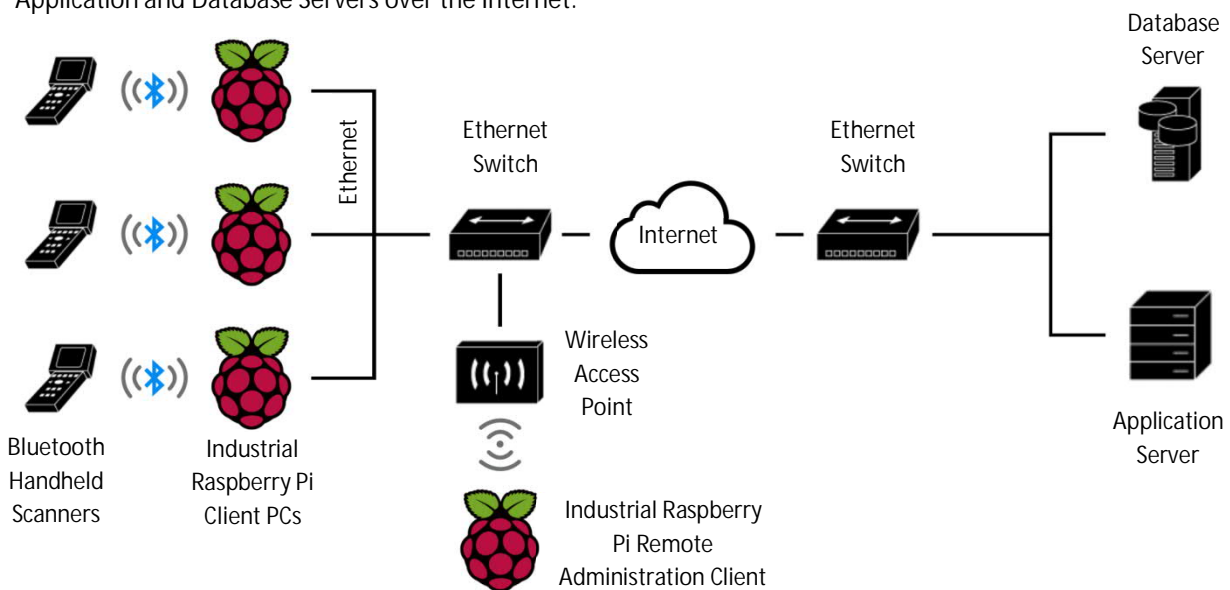

Raspberry Pi is a trademark of the Raspberry Pi Foundation.

Other System Options

EXTENDED FUNCTIONALITY AVAILABILITY				
PRODUCT TYPE	PANEL PC	AXEL THIN CLIENT	RASPBERRY PI CLIENT	MONITOR
Wi-Fi	802.11ac, 802.11a/b/g/n (optional)	802.11a/b/g/n (optional)	802.11ac, 802.11a/b/g/n (included onboard)	N/A
Bluetooth	5.0 BLE (optional)	N/A	5.0 BLE (included onboard)	N/A
Thermal Control	Yes (optional)	Yes (optional)	Yes (optional)	Yes (optional)

Thermal Control

In the case where the motherboard power rating stays the same for both standard operating temperature and extended, this means that the motherboard is capable of the extended operating temperature detailed, and no thermal control is required. Otherwise, an internal controller with a temperature sensor continuously monitors the internal ambient temperature and regulates this by use of a heater PTC F-Plate (2 x 60W). This allows the lower operating temperature of the product to be extended to -25°C (external).

The controller can hold off power from the main electrical components of the product, ensuring that a safe internal ambient temperature is reached before they are powered, prolonging the life of the product.

Customisation

Colour	Full customisation of case colour and logos available
OS / Software	Contact us for further details
I/O Sockets	See Appendix D for details

Accessories

Mounting	Mounting kits include pedestal and wall mount brackets. Pedestals are available in brushed Stainless Steel and in various sizes from 1m to 3m.
----------	--

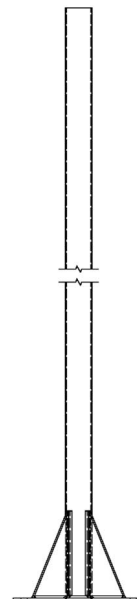
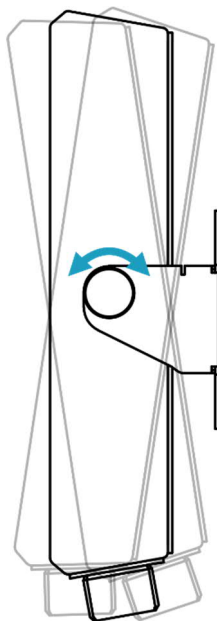

Appendix D

There are various options for the input and output connectors in the W21 product range. Each option offers a different level of sealing and protection and is dependent on the configuration of the product.

The table below shows the different connector options and their IP rated sealing levels.

CONNECTOR SEALING OPTIONS		
OPTION	IP RATING	DESCRIPTION
K	IP66	Cased – Bottom Outlet - EPG Kit
T	IP67	Cased – Bottom Outlet - Metal Locking
Z	IP22	Bezel – Bottom Outlet Connections

Option K – Bottom Outlet - EPG Kit

The EPG (Entry Plate Grommet) Kit is rated at IP66, achieving complete protection against dust ingress, and water projected in powerful jets (12.5 mm (0.49 in)) against the installed EPG kit from any direction shall have no harmful effects.

The grommets are available for cables from 2 to 17 mm diameter. The 2X and 4X versions allow multiple cables in the same grommet. There is also a “blind” version available.

Some possible configurations are shown below:

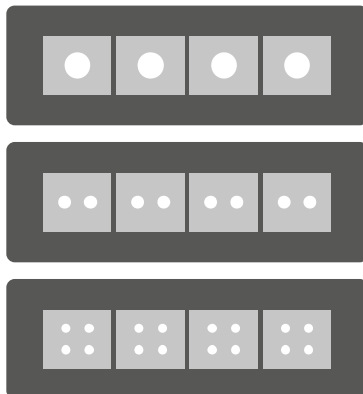

Option T – Bottom Outlet - Metal Locking

The Metal Locking connectors are rated at IP67, achieving complete protection against dust ingress, and effective protection against water ingress in harmful quantities when immersed in water for up to 1m of submersion and for a duration of up to 30 minutes.

A simple quarter turn is all that is required to lock your connector in place, making sure that you lose no connectivity to the PC due to dust or water ingress, or from being disconnected accidentally.



Using our standard 7-hole connector plate, the desired connector area configuration may only be reserved to 7 connections. One port must be reserved to AC/DC POWER IN, unless a different method of powering is used such as PoE (Power over Ethernet).

EXAMPLE 7-HOLE LAYOUT PANEL PC CONFIGURATION

MOTHERBOARD	N100	I5	STANDARD
AC/DC POWER IN	1	1	1
LAN	1	2	1
USB3	2	2	2
USB2	0	0	0
COM	3	2	1

The below diagram is an illustration of the standard configuration in the table above.

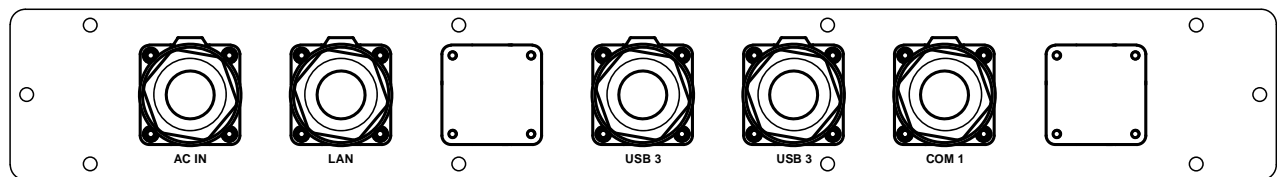

Cables are available in 2 or 5 metres length.

Dimensions Cased – With Bracket, 'K' Bottom Seal

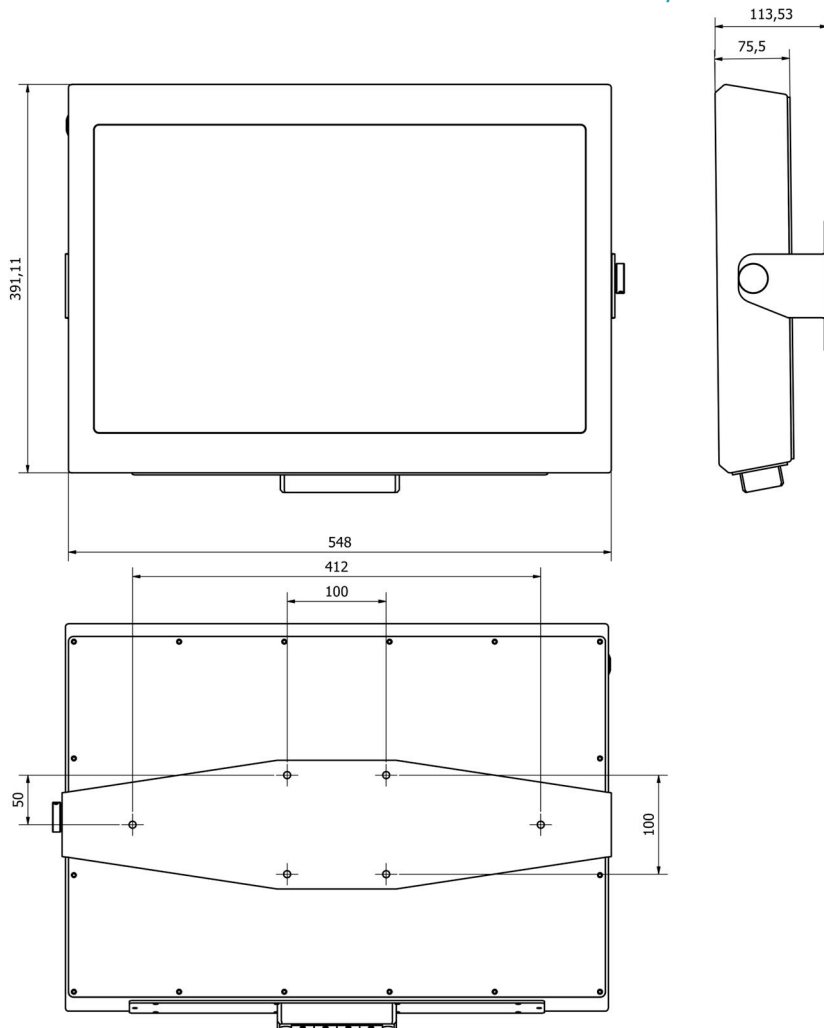

Dimensions Bezel

